

INSTRUKCJA MONTAŻU ŚCIANKI SEG

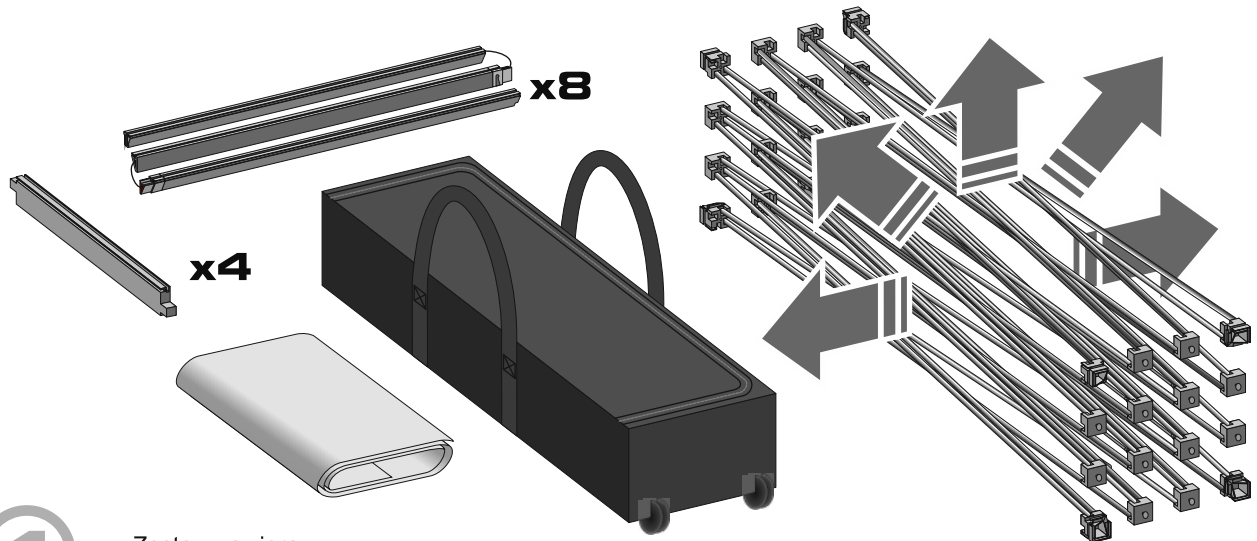

1

- Zestaw zawiera:
- ściankę SEG
 - grafikę
 - torbę transportową
- Opcjonalnie:
- 2 sztuki lamp (4,5 m)
 - metalowe stopy

OPCJONALNIE

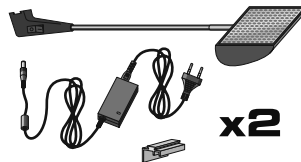

OPCJONALNIE

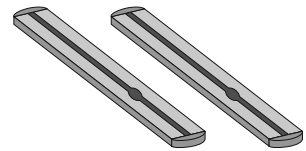

2

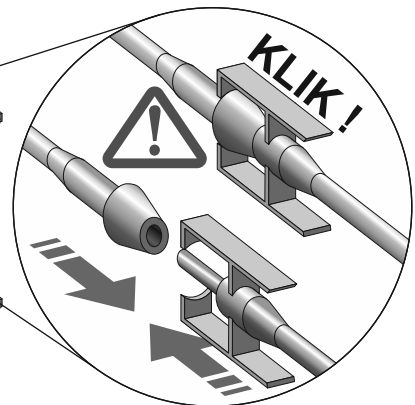
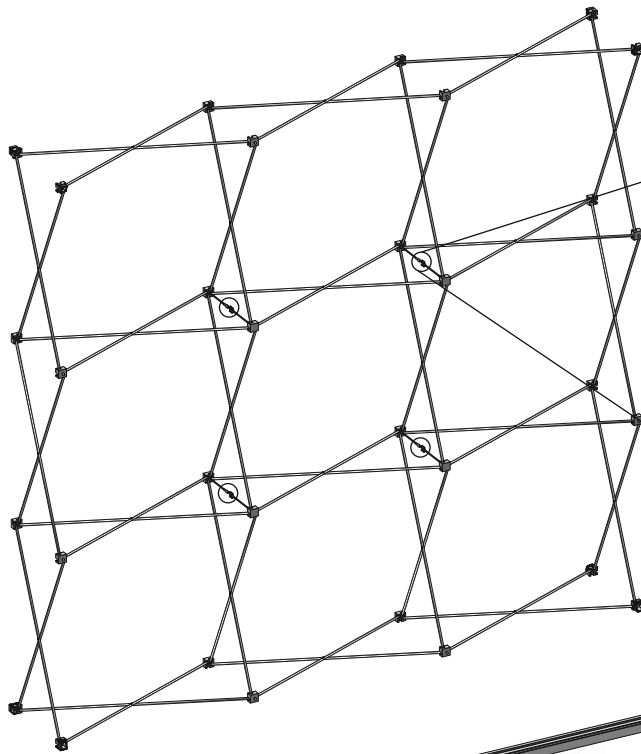

3

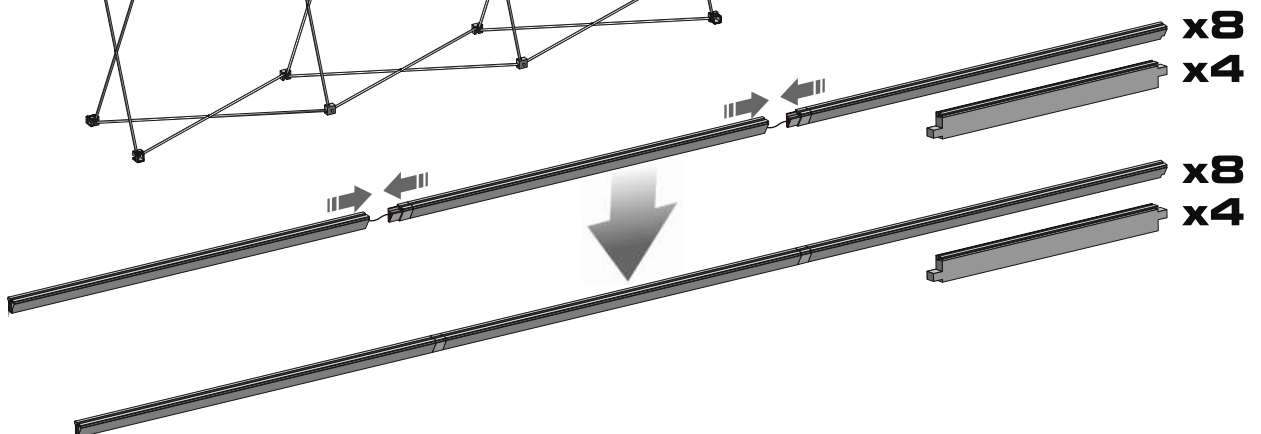

3

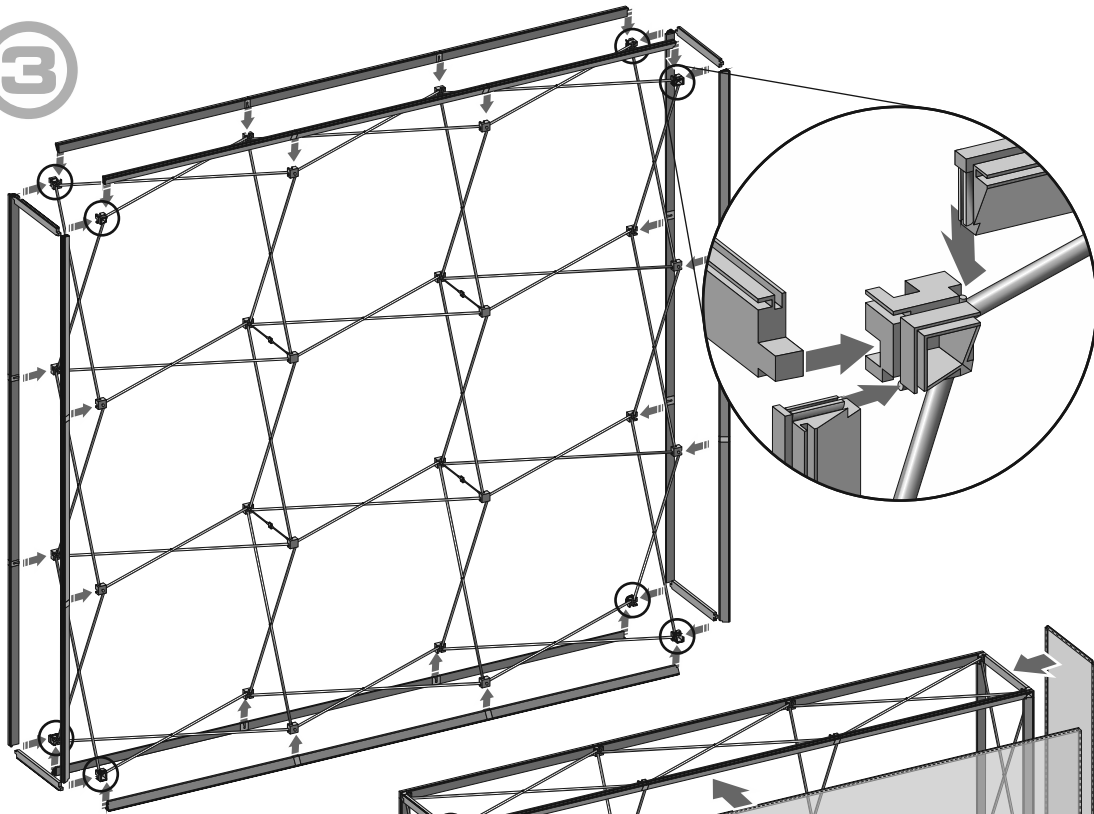

4

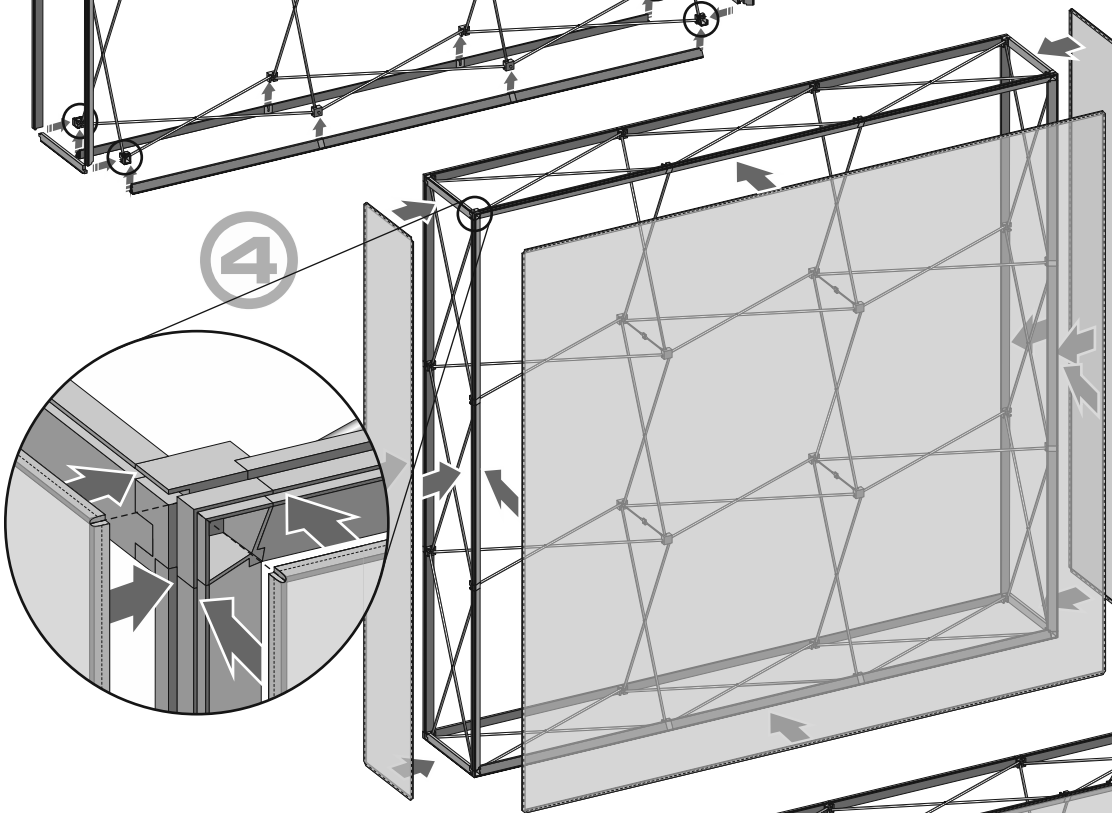

5

OPCJONALNIE

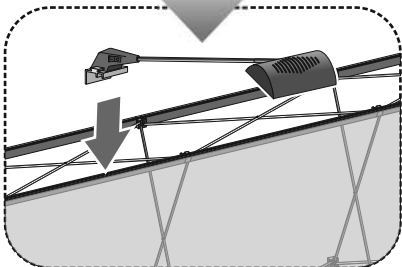
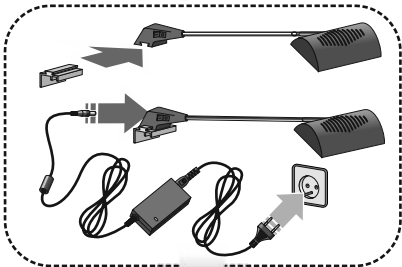

OPCJONALNIE

